



emco entrance matting systems

**Strong protective shield
for the entrance**

Designing clean entrances.

EMCO

Contents

Basics and background knowledge

This is why entrance matting systems are worthwhile	4
emco advantages at a glance	6
The emco 3-zone cleaning system	8
Using 3-zone cleaning correctly	10

NEW!

emco products

emco Premium entrance mats vs. original entrance mats	12
The difference between DIPLOMAT and MARSCHALL	14
Premium entrance mats at a glance	16
Premium entrance mats with Performance inserts	18
Original entrance mats with standard inserts	20
Dirt collection zones individually arranged	22
emco installation frames and other accessories	23
emco clean-off	24
Clean-off in the entire building	26

emco special solutions

emco special solutions	28
Services	32
International references	34



Gelderlandplein, Amsterdam (NL)

Architects: Rijnboutt Architecten, Amsterdam

Products: emco 3-zone cleaning with
emco **MARSCHALL PREMIUM**

Gelderlandplein



This is why entrance matting systems are worthwhile

Safe, clean, sensational

The entrance area is your building's ambassador. However, it is also the bottleneck through which everyone enters. This means that large quantities of street dirt accumulate here every day. An enormous challenge, which must be met intelligently. Entrance matting systems by emco provide systematic and powerful protection, like a protective shield. Dirt but also accidents caused by slipping and damage have no chance. For a radiant first impression.

Did you know ...

... that emco entrance matting systems guarantee continuing value preservation?

Entrance areas are bottlenecks that every visitor passes through. The entrance area is therefore not only exposed to particular stress, it also protects the entire building from dirt and dust. This is why it needs valuable support. emco entrance matting systems protect every square metre of your property.

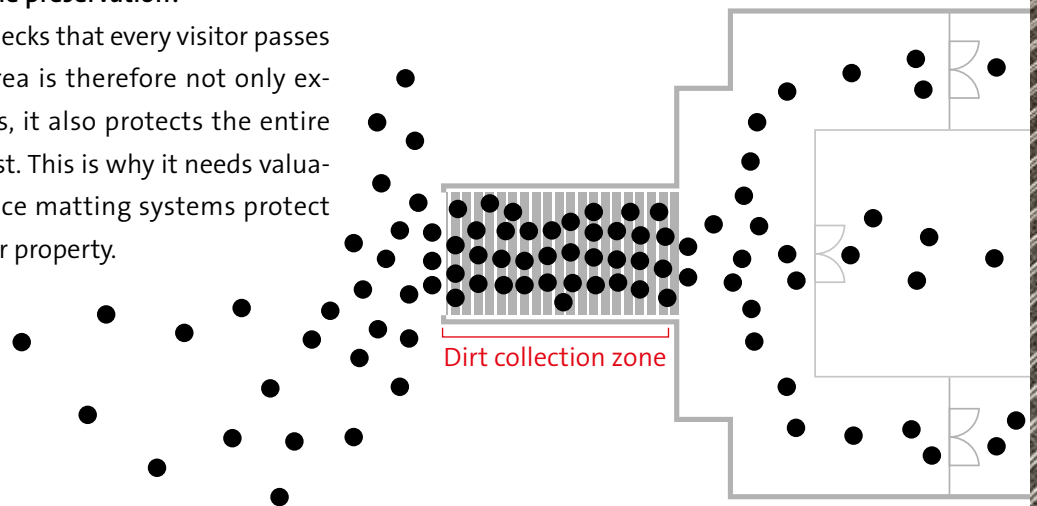



emco advantages at a glance

Highly convincing

As a strong protective shield for the entrance, emco entrance matting systems must be able to do much more than simply deal with dirt. They must always be ready for use, stand up to high stress and also be able to cope with crowds without any problems. The focus is equally on the protection of persons and property. emco entrance matting systems score points with six outstanding advantages:

SAFE



Prevents accidents caused by slipping and satisfies the duty to ensure public safety

VALUE-PRESERVING



Prevents expensive damage to the internal floor covering and thus preserves the value of the property

TESTED



Offers certified products that have been put through their paces by TÜV (Technical Inspection Agency)

ECONOMICAL



Reduces the dirt carried into the building by up to 90 per cent

SIMPLE



Extremely easy to install, especially with emco 360° service

SUSTAINABLE



Reduces the consumption of cleaning agents and supports LEED/BREEAM/DGNB certifications



The emco 3-zone cleaning system

3 power zones for immaculate cleanliness

It is the combination of three different zones that makes the emco entrance matting system so powerful. Each individual zone is in itself extremely effective and enormously resilient, but together they develop their full power. The first zone has special inserts to prevent coarse dirt from entering the building. The second zone with a non-slip insert material ensures that fine and damp dirt is removed. The third zone absorbs residual moisture and dirt and not only prevents accidents caused by slipping, but also prevents dirt being brought into the building from the mats themselves. Only emco offers this powerful triple combination.

Did you know ...

... that emco entrance mats keep perfectly clean and are particularly easy to clean?

All emco entrance mats are designed in such a way that after the dirt has been removed, it falls through the gaps into the mat well. This guarantees their high degree of functionality. At the same time, emco entrance mats are particularly easy to clean because they can be rolled up. When it is time to clean the mat well, the entrance mat can simply be rolled up, lifted out and stored away. It can then be fitted again in the twinkling of an eye.





Dirt collection zone 1
Catches coarse dirt

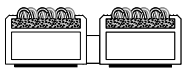

Dirt collection zone 2
Removes fine dirt
and moisture



Dirt collection zone 3
Absorbs residual moisture
and dirt

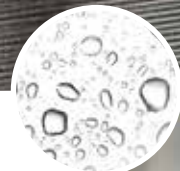

Using 3-zone cleaning correctly

Easy to install – threefold savings

Give your entrance matting system just as much attention as your internal floor covering – it is worth it, for emco 3-zone cleaning not only provides comprehensive protection against dirt and building damage, it also ensures that expensive cleaning costs are reduced step by step. Each zone alone already reduces the need for cleaning, but when installed as a complete system, you will have the power of 3 zones that will reduce the dirt input by up to 90 percent.



Approx. 40%*
dirt reduction



Dirt collection zone 1



Dirt collection zone 2

Did you know ...

... that the perfect length of an entrance matting system is at least 9 metres?

In a worst-case scenario, every visitor carries up to 12 grams of dirt into a building. Course dirt, fine dirt, moisture and in winter, even aggressive de-icing salt. In order to collect all this dirt reliably, we recommend a 12 step contact or 3 wheelchair revolutions on our entrance matting system. With an average stride length of 75 cm, this means that the optimum length of the emco entrance matting system is at least 9 metres.

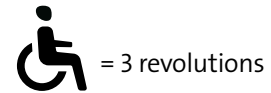
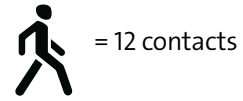

9 m

*when all three zones are combined

1 > 2 > 3

Dirt collection zone 3

emco Premium entrance mats vs. original entrance mats

You have the choice!

In addition to our original inserts, we have developed a range of completely new Premium inserts so that you can benefit from such strong properties as tested fire behaviour and considerable reduction in walking noise. But no matter which format you choose, emco will always convince you with high quality.

We have completely optimised our entrance matting system for you:



Easier orientation

Clear structuring of our products for even easier selection and combination



TÜV-certified products

Both our Premium and our original products have been intensively tested by TÜV.



Consistent design

Thanks to the new variety of Premium inserts, you can easily develop a uniform design.



Greater efficiency

Our entrance mats now absorb even more dirt and moisture and even reduce walking noise. They are also significantly more durable and abrasion-resistant.



System extension

Our entrance mats are now available in all standard profile heights and insert widths for normal and heavy loads (in the Premium version).

Original entrance mats

- ✔ significant reduction in walking noise
- ✔ tested anti-slip behaviour
- ✔ tested stress

Premium entrance mats

- ✔ improved reduction in walking noise
- ✔ increased moisture absorption
- ✔ increased dirt absorption
- ✔ tested anti-slip behaviour
- ✔ stress class suitable for properties
- ✔ tested fire behaviour
- ✔ uniform design
- ✔ compliance with emission regulations

NEW!



The difference between DIPLOMAT and MARSCHALL

It depends on the load

All emco entrance mats are available with two load-bearing profiles. The DIPLOMAT profile is ideal for buildings with normal and heavy loads such as hotels, shops, doctors' surgeries or private entrance areas. The MARSCHALL profile offers special protection under extreme loads, for example, also stands up to being driven on with industrial trucks, without any problem whatsoever. It is ideal for use in shopping malls or airports. You can thus adapt your entrance mat perfectly to meet the required building load. And if the situation changes, for example due to renovation, you can easily retrofit the existing system.

Did you know ...

... that our entrance mats are now available in all standard profile heights and widths?

We have extended our system so that you can choose your own personal emco entrance mat regardless of the load and the installation situation. All emco entrance mats are now available with standard profile heights of 12, 17 and 22 mm. We have also optimised our profile widths for you: In the Premium version, all inserts are now also available as a wide version. In the original version, the ribbed inserts are also available in a wide form. This means that you are equipped for any load situation and also benefit from the greatest possible flexibility, even when space is limited or special refurbishment requirements apply.

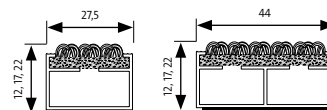

emco **DIPLOMAT**
for normal to heavy loads

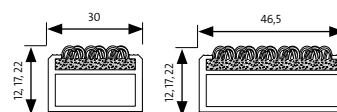

emco **MARSCHALL**
for extreme loads



emco **MARSCHALL**



For entrances with extreme loads, e. g. shopping centres, airports, hospitals and railway stations.



emco **DIPLOMAT**



For entrances with normal to heavy loads, e. g. for residential, administrative and office buildings

Premium entrance mats at a glance

Top class to meet the highest standards

NEW!

The entrance mats DIPLOMAT Premium and MARSCHALL Premium offer TÜV-certified products, perfect cleaning and maximum safety. However, the precision dirt collectors with polyamide inserts are also the first choice when it comes to attractive design and stylish building architecture.

Did you know ...

... that polyamide is the basis for the effectiveness of our Premium products?

Our Premium inserts are made of polyamide. This allows them to absorb a lot of moisture and dirt. With their outstanding sustainability properties, they also help to make a building fit for LEED, BREEAM or DGNB certification.



Mitglied der
DGNB



TÜV certified products
We are the first company to face up to the strict TÜV test with our entrance mats.



tested anti-slip behaviour



increased dirt absorption



improved reduction in walking noise



stress class suitable for properties



compliance with emission regulations



increased moisture absorption



tested fire behaviour



uniform design

Premium entrance mats with performance inserts

DIPLOMAT PREMIUM and MARSCHALL PREMIUM

New variety with smart extras

1 2 3 Dirt collection zone 1

Colours

- OUTDOOR insert//** The special one
- ✓ good scratching properties
 - ✓ optimum absorption of coarse dirt
 - ✓ high abrasion resistance
 - ✓ radiant vitality
 - ✓ also suitable for outdoor use

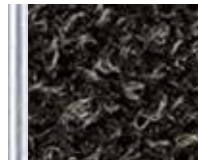

Anthracite



Brown



Red

1 2 3 Dirt collection zone 2

Colours

- CARE insert//** The robust one
- ✓ highly robust
 - ✓ high light fastness
 - ✓ effective dirt reduction
 - ✓ effectively protects high-quality floor coverings

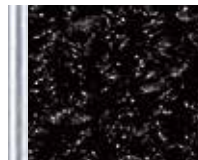

Anthracite 47.01



Grey 47.02

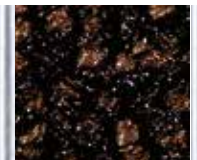

Brown 47.03



Beige 47.04

- MAXIMUS/MAXIMUS IMAGE insert//** The individual one
- ✓ high quality tufted velour
 - ✓ excellent protective properties
 - ✓ optimum yarn mix for absorbing dirt
 - ✓ individually printable (MAXIMUS IMAGE)



Anthracite 80.02

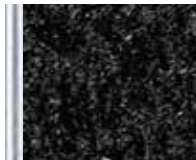

Black 80.01



Black mottled 81.01



Brown 80.04

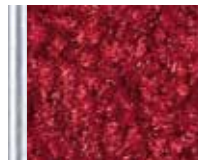

Red 80.07

- Aero insert//** The fine dust absorber
- ✓ elegant colouring
 - ✓ made from regenerated resources (Econyl)
 - ✓ carpet character
 - ✓ very firm surface structure



Anthracite
A886-9511

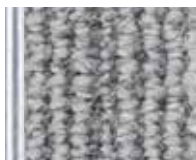

Grey
A886-1504



Brown
A886-9104



Beige
A886-1958

1 2 3 Dirt collection zone 2

Colours

CONFORM insert// The ecological one

- ✓ exclusive velour
- ✓ made from regenerated resources (Econyl)
- ✓ highly versatile
- ✓ colouring specially matched to wood



Anthracite 76.01

Brown 76.04

Beige 76.02

INNOVA insert// The adaptable one

- ✓ distinguished appearance
- ✓ consistent dirt reduction
- ✓ improves room acoustics
- ✓ hides dirt



Anthracite 36.02

Grey 36.03

Black 36.01

www.emco-bau.com/Premium

The field of application

Depending on the type of load, you can choose between two different emco profiles for your Premium entrance mat with Performance insert:



emco DIPLOMAT PREMIUM

For entrances with normal to heavy loads

- e. g. for residential, administrative and office buildings
- heights: 12, 17, 22 mm
- all inserts also available in a wide design

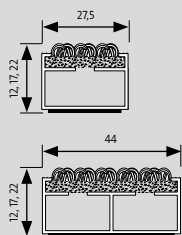

emco MARSCHALL PREMIUM

For entrances with extreme loads

- e. g. for shopping centres, airports, hospitals and railway stations
- heights: 12, 17, 22 mm
- all inserts also available in a wide design

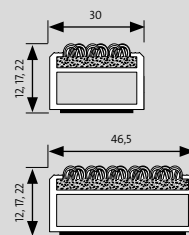



Original entrance mats with standard inserts

DIPLOMAT ORIGINAL and MARSCHALL ORIGINAL

Proven quality and cleaning performance

1 2 3 Dirt collection zone 1

Colours

Rubber insert

- ✓ for extra-large amounts of coarse dirt
- ✓ high abrasion resistance
- ✓ resistance to weathering
- ✓ elegant appearance
- ✓ also suitable for outdoor use



Black

Cassette brush insert

- ✓ for extra-large amounts of coarse dirt
- ✓ especially durable brushes
- ✓ resistant to weathering
- ✓ high abrasion resistance
- ✓ also suitable for outdoor use



Black

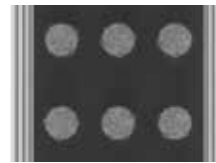

Grey

1 2 3 Dirt collection zone 2

Colours

Coarse fibre ribbed insert

- ✓ particularly resistant to abrasion
- ✓ very high dimensional stability
- ✓ extreme durability
- ✓ resistant to weathering



Anthracite



Light grey



Brown



Sand



Red



tested stress



significant reduction in walking noise



tested anti-slip behaviour



The field of application

Depending on the type of load, you can choose between two different emco profiles for your Original entrance mat with Standard insert:



emco DIPLOMAT ORIGINAL

For entrances with normal to heavy loads

- e. g. for residential, administrative and office buildings
- heights: 12, 17, 22 mm
- ribbed inserts also available in a wide design

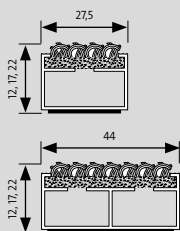

emco MARSCHALL ORIGINAL

For entrances with extreme loads

- e. g. for shopping centres, airports, hospitals and railway stations
- heights: 12, 17, 22 mm
- ribbed inserts also available in a wide design

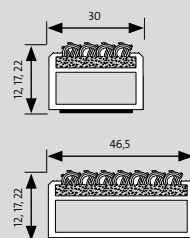



Dirt collection zones individually arranged

The cleaning boost for the entrance

You can structure your dirt collection zone individually so that you can benefit from the entire emco cleaning power, even when space is limited or the dirt load is particularly high. For example, you can combine inserts for different dirt collection zones to optimise dirt abrasion even when the installation length is limited. Additional emco profiles can be practically combined to provide that extra cleaning effect. With separate scraper bars or brush strips fitted between the profiles, you can further increase the effectiveness of your emco entrance matting system.

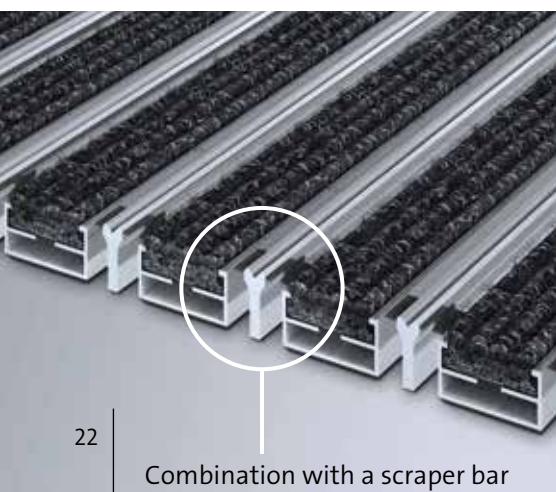
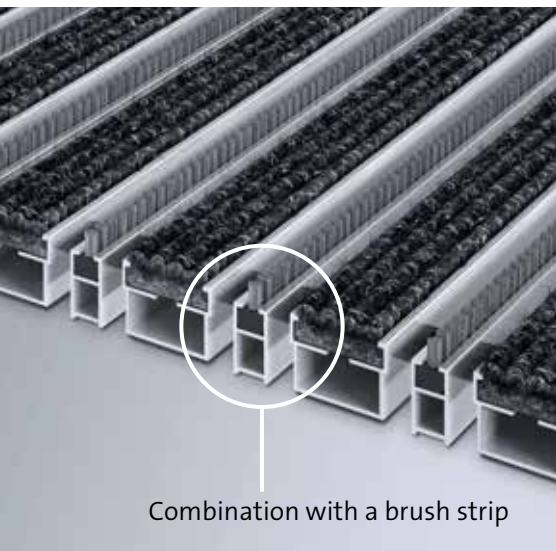



emco installation frames and other accessories

The anchor for the entrance matting system

emco installation frames keep the entrance matting system safely under control. In the basic version, the frames consist of high-quality angle profiles and are available in a wide variety of designs. Whether made of aluminium, brass or stainless steel, rectangular or in special shapes especially for your building, the installation frames will win you over with their flexibility. In addition to installation frames, our accessories also include cover strips and ramp edges. We will be happy to advise you.



emco **installation frame 500**, aluminium



... brass



... stainless steel



emco clean-off

How to preserve the quality of your floor

Internal floor coverings suffer a constant loss in value due to dirt since, at the same time, it often causes damage such as scratches, permanent stains or also loss of colour intensity in textile coverings. It is therefore worth planning as long a clean-off area as possible and giving the dirt collection zone 3 plenty of room. This also increases slip resistance enormously on the subsequent floors, since it absorbs a lot of moisture. Optimally set up, it thus protects people and floor covering and also maintains a well-kept, distinguished appearance for your entrance in the long term.

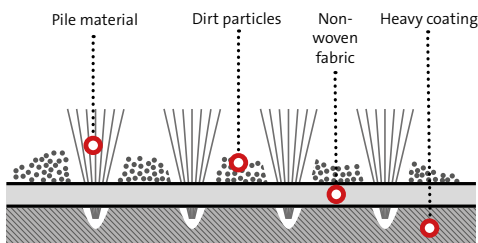

Special fibres for attractive cleanliness

Through the use of special hollow fibres, their special arrangement and the use of an extremely absorbent non-woven fabric, emco clean-off floor coverings can absorb a lot of dirt and moisture.

CARE



Anthracite 47.01 Grey 47.02 Brown 47.03 Beige 47.04

MAXIMUS



Anthracite 80.02 Black 80.01 Black mottled 81.01 Brown 80.04 Red 80.07

CONFORM



Anthracite 76.01 Brown 76.04 Beige 76.02

INNOVA

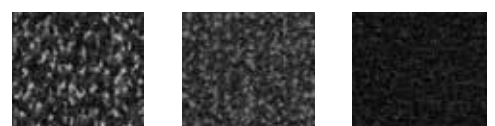

Anthracite 36.02 Grey 36.03 Black 36.01



residual dirt
absorption



consistent
design



protection of the
subsequent floor covering



prevents accidents
caused by slipping



Deichtorcenter Hamburg (D)
Architects: Spengler Wiescholak
Architects, Hamburg
Product: emco **MAXIMUS**



Clean-off in the entire building

Cross-room precision in dirt collection

Not only in the entrance area does sustainable protection from dirt pollution of all kinds pay off. This is why emco entrance matting systems are also the right choice inside the building when it is a question of preventing dirt from being distributed. Heavily frequented areas, such as canteens, benefit from the safe protection of the clean-off just as much as the coffee corner on the office floor.

Did you know ...

... that a clean-off protects not only the entrance area?

It reliably protects you from dirt accumulation, ensures that moisture is not carried on and is much easier to replace if necessary. Clean-off floor coverings are therefore not limited to the entrance area alone, but can be used throughout the building to maintain its value and create an attractive appearance.



emco special solutions

Special requirements? No problem!

Some entrance situations require special, adapted solutions. Be it due to extreme loads in the industrial sector, prescribed accessibility requirements or special requirements for mat design and entrance layout

Tactile

Entrance mat solutions for visually impaired and blind persons.

- ✓ SPIN® SAFE
- ✓ TLS
- ✓ MAXIMUS ASSISTANCE

Mat alternatives

Extremely resilient mats, which ensure maximum cleanliness in the industrial sector.

- ✓ X-TREME
- ✓ PLAZA
- ✓ KADETT

Rubber honeycomb mats

Highly versatile rubber honeycomb mats – robust, effective, universal.

- ✓ LIMBUS
- ✓ CUBUS
- ✓ STRUCTURA

Dirt collection wells

Indispensable in case of increased dirt accumulation in heavily frequented entrance areas.

- ✓ Dirt collection well
- ✓ Substructure

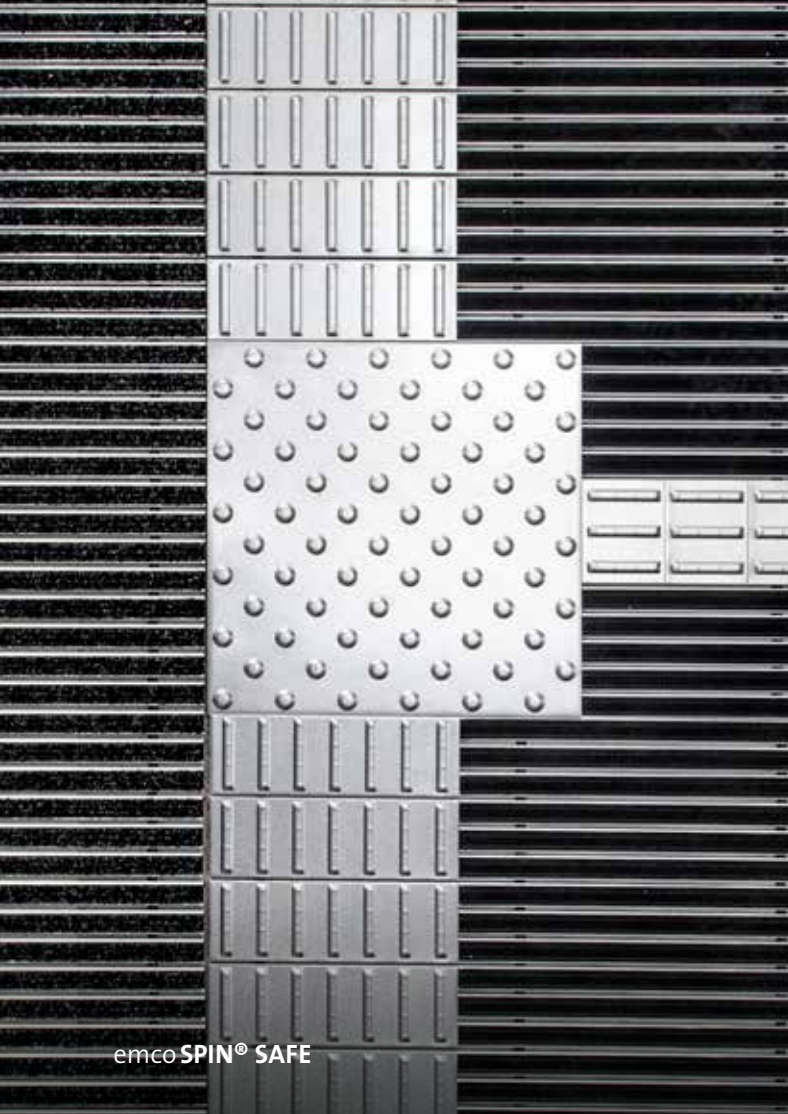

emco SPIN® SAFE

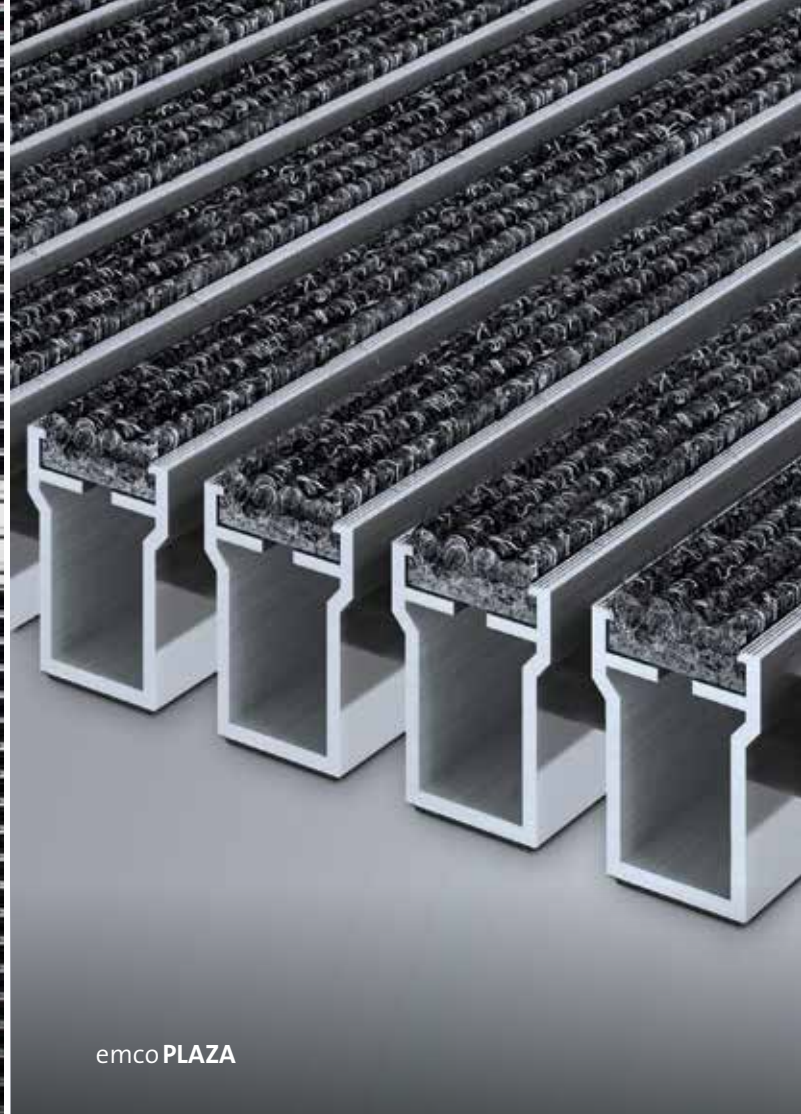

emco PLAZA

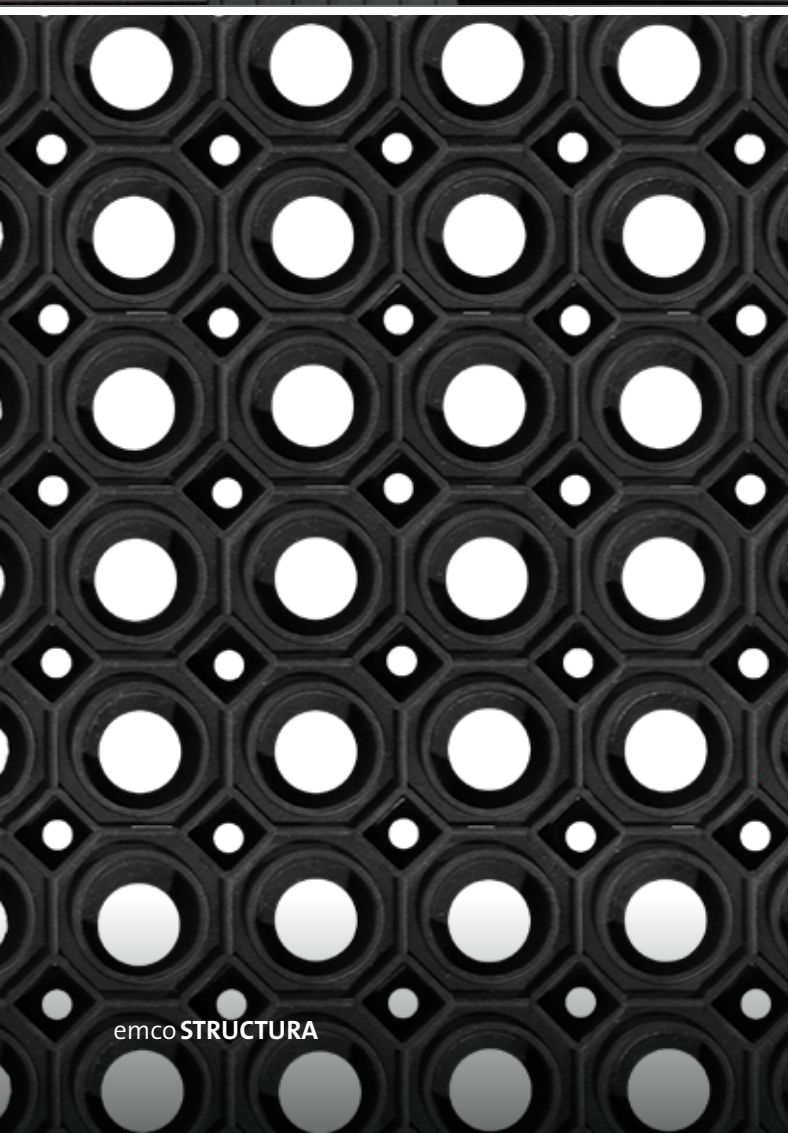

emco STRUCTURA



emco dirt collection well

emco special solutions

Personalised design for real eye-catchers

Individual entrances can be created with entrance matting systems by emco – not only in form and colour. Our special design solutions turn every entrance area into a real highlight – with curved mats, customisable stainless steel elements or high-quality illuminated frames. Ideal design, particularly for entrances with round shapes.

emco **LUMINA**

The LED illuminated frame system turns simple entrance areas into particularly stylish highlights.

- ☑ LUMINA
- ☑ LUMINA VIA

emco **MAXIMUS IMAGE**

The room design element with individual printing for creative and image-conscious people.

emco **INOX®**

Laser-cut individualised stainless steel elements as advertising media – the finishing touch for the entrance mat.

- ☑ LINEO
- ☑ QUADRO

emco **T-PROFILE**

Aluminium profile for creating the visual separation of adjacent entrance mats.

emco **COLOR EDITION**

Aluminium profiles anodised in colour – for an even more colour-coordinated design for your entrance matting system.

emco **RADIAL**

An extravagantly rounded form for architecturally sophisticated properties.



emco LUMINA VIA



emco MAXIMUS IMAGE



emco INOX® LINEO



emco T-PROFILE

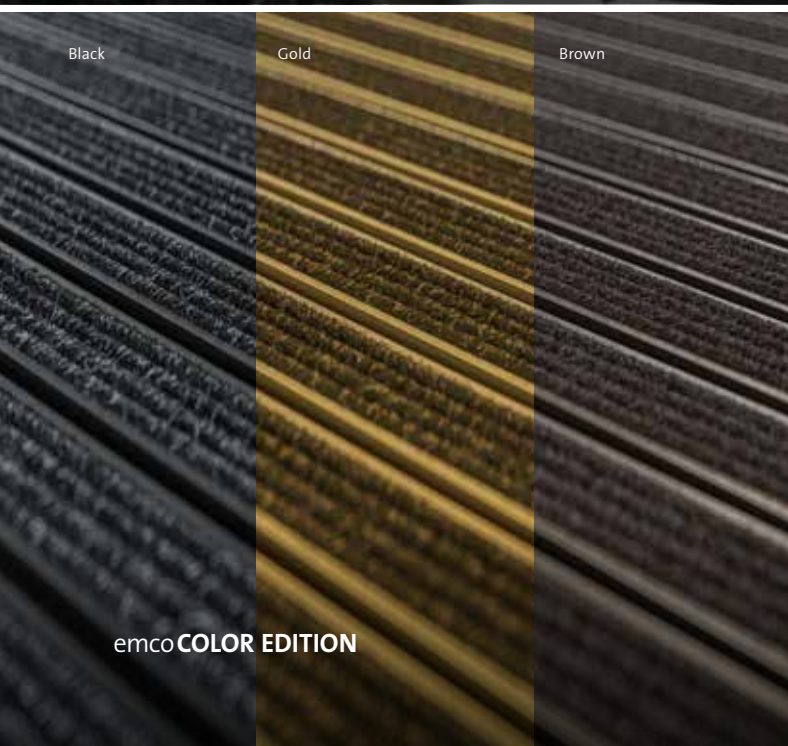

Black

Gold

Brown

emco COLOR EDITION



emco RADIAL

Services

360° service just in case

We want to make your everyday life as simple as possible: take advantage of our convenient services such as our cleaning or measuring service. Our experts are always at your service. In addition to basic components, we naturally also provide comprehensive accessories for the entrance area, giving you maximum freedom of design.

Consulting service

If you have any questions about a product, particularly tricky installation situations or comprehensive planning, simply contact us and we will support you.

Measuring service

Our experts can facilitate your planning enormously by measuring the entrance area with the help of a laser measuring device and their technical know-how.

Modernisation service

Benefit from our replacement service. When emco systems need to be renovated, our professionals will either replace the inserts or, if necessary, the entire mat system.

Repair service

If you need a partial repair, such as the replacement of a profile, emco offers fast on-site service.

Installation service

For extra comfort: our professionals can carry out the complete installation of your emco entrance mats.

SERVICE-CONTACT

How to reach us:

Tel: +49 591 / 9140 - 501

bau@emco.de

www.emco-bau.com/service



Consulting service



Measuring service



Modernisation service



Repair service



Installation service

International references

At home in the world

It is not only in Germany that people rely on the powerful protection of emco. Whether in Sweden, France or Belgium, wherever valuable architecture and highly frequented public buildings require reliable protection against dirt, clever operating companies, flooring experts and investors rely on the powerful 3-zone cleaning system.



Ozeaneum Stralsund, Germany
Architects: Behnisch & Partner



Palais Vest, Germany
Architects: Auer + Weber + Assoziierte



Emporia Malmö, Sweden
Architect: Gert Wingårdh



Liège railway station, Belgium
Architect: Santiago Calatrava



Auditorium AZ Groeninge Kortrijk, Belgium
Architects: Dehullu Architecten



Libeskind Villa, Germany
Architect: Daniel Libeskind



More from emco:



emco carpet mats – individual in shape and motif

Carpet mats by emco stand for top processing quality and maximum individuality. In addition to standard formats, shape mats are possible in almost any format. 45 bright standard colours as well as special colours can be implemented on request.



emco swimming pool grates – safe, hygienic and durable

Swimming pool grates by emco efficiently collect overflow water, are gentle on the feet and meet the highest safety and hygiene standards. The grates have an embossed safety profile and safety certification, and can be produced in almost any shape.



emco rolling foot grids – high-quality and variable

Whether for private residential areas, commercial spaces, outdoor areas or sports halls – emco always offers the right rolling foot grid. Whether aluminium, steel, polyester or wood, allow us to impress you with our wide range of colours and materials.

emco Bautechnik GmbH
Postfach 1860
D-49803 Lingen (Ems)
Germany
Tel. +49 (0) 591 9140-500
Fax +49 (0) 591 9140-852
bau@emco.de

www.emco-bau.com



A member of the